

LT 21 K 50 P3

Laser Diffuse Sensor

- High operating distances with a small design
- High resolution
- Visible red light with small light spot
- Sensitivity adjustable
- LED indicator for output state

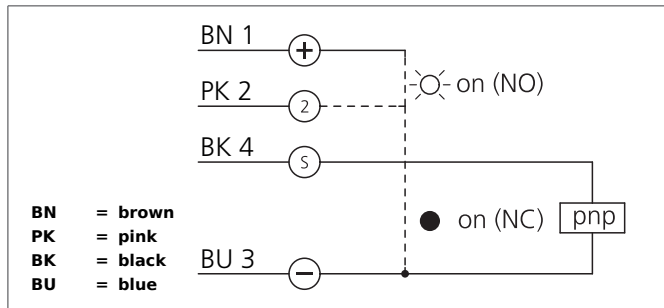

Safety instructions

Inproper use may result in hazardous radiation exposure. Pay attention to accident prevention rules and laser class. The instruments are not to be used for safety applications, in particular applications in which safety of persons depends on proper operation of the instruments. These instruments shall exclusively be used by qualified personnel.

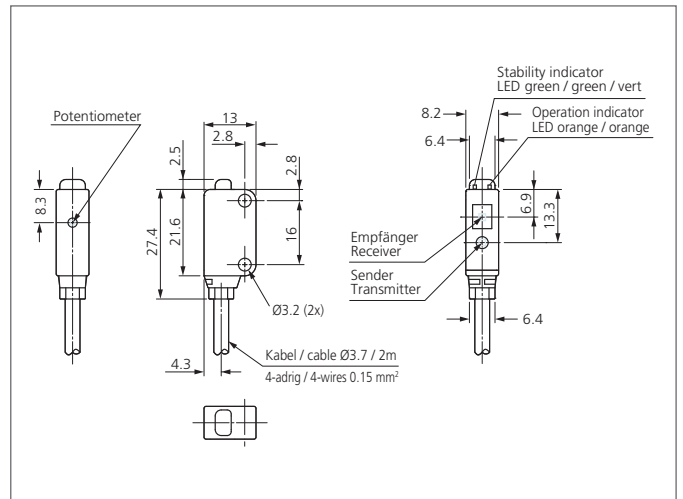

TECHNICAL INFORMATION (typ.)		+20°C, 24V DC
Operating principle		Diffuse reflective sensor
Evaluation		digital
Size		22 x 13 x 8.5 mm (Dimensions)
Design		cuboid design
Emitted light		Red light laser, 655 nm, clocked
Laser class		1 (IEC 60825-1)
Service voltage		10,8 ... 26,4 V DC
Internal power consumption		15 mA
background suppression		no
Operating distance		20 ... 50 mm
Resolution		Ø 1,0 mm (at operating distance 50 mm)
Smallest detectable object		Ø 0,01 mm (gold wire)
Sensitivity adjustment		potentiometer
Switching output		pnp, 50 mA, NO/NC
Switching hysteresis		20 %
Switching frequency		1.000 Hz
Response-/release time		0,5 ms
Ambient temperature		-10 ... +55 °C
Vibration/Shock resistance		10 ... 500 Hz / 1,5 mm / 10 G
Ambient light immunity		3 kLx
Insulation voltage endurance		1.000 V
Protection class		IP 67
Protection degree		III, operation on protective low voltage

LT 21 K 50 P3

Laser Diffuse Sensor



TECHNICAL INFORMATION (typ.)		+20°C, 24V DC
Casing material		plastics
Material		Acrylic (Window)
Connection		Cable, 2 m, 4-poled, flying leads